

TOOL ROOM & TRAINING CENTRE, GUWAHATI



INFORMATION BROCHURE 2026-27



Tool Room & Training Centre, Guwahati

Ministry of Micro, Small & Medium Enterprises, Govt. of India

Amingaon Industrial Area, North Guwahati Road, Amingaon, Guwahati - 31

Website: www.trtcguwahati.org

Email: trtcghy@hotmail.com

INTRODUCTION

Tool Room & Training Centre, Guwahati has been established by Government of India to cater tooling and training need of Industries of North Eastern Region. The State Government of Assam has provided the land as well as initial building to the Tool Room. TRTC has been registered as Government of India Society on 24th February 2000. It is situated at Amingaon Industrial Area, North Guwahati Road, Guwahati-781031. It is a sprawling campus with Administrative Block, Training Block, Modern Workshop, Knowledge Centre, Staff Quarters and Hostel.

The management of the affairs of the Centre rests with the Governing Council constituted by Government of India. Additional Secretary and Development Commissioner (MSME), Government of India, is the President of the Society and the Chairman of the Governing Council.

The training department provides quality training in the field of Design with CAD/CAM/CNC Machining with latest high-tech software's , Machine Tool Operation, Precision Machining, Welding Technology, IT, PLC etc. The production wing manufactures press tools, moulds, jigs & fixtures, gauges and other precision components as per the needs of the industries.

In pursuit of excellence, Tool Room & Training Centre, Guwahati has been awarded with an IS/ISO 9001:2015 and IS/ISO 14001:2015 certifications.



OUR CENTRES:

**TOOL ROOM & TRAINING CENTRE, AGARTALA
BAMBOO PARK, R. K. NAGAR, AGARTALA-799008**

**TOOL ROOM & TRAINING CENTRE, TINSUKIA
INDUSTRIAL ESTATE, NEAR GM DI&CC, BORGURI, TINSUKIA-786126**

**TOOL ROOM & TRAINING CENTRE, JORHAT EXTENSION CENTRE
RAJABARI, JORHAT-785014**

**TOOL ROOM & TRAINING CENTRE, CITY CENTRE, BAMUNIMAIDAM,
GUWAHATI-781021**

AIMS & OBJECTIVES

- **To impart Long Term, Mid Term and Short Term Training to youngsters with the latest technologies (and other allied engineering trades) both for fresher's and personnel already engaged in this field.**
- **To provide qualitative service in the area of Development & Manufacturing of Precision Tools & Components, Design, Project Consultancy.**
- **To develop production facilities of moulds, jigs, fixtures, gauges & other sophisticated tools preferable for Small Scale Industries.**
- **To Train manpower in the field of industrial engineering & other allied engineering trades both for the fresher's and for personal already engaged in the field.**
- **To provide common facilities in precision machining.**
- **To provide consultancy facilities primarily for MSMEs units in the field of tool engineering aimed at improvement in productivity.**
- **The aim of the Centre is to promote growth and development of Micro, Small & Medium Enterprises through Technological and Skilled Manpower Support.**

CAREER ORIENTED COURSES OFFERED FOR DIFFERENT LEVELS & DIFFERENT DISCIPLINES

**ITI TRADES
(AFFILIATED BY
NCVET/SCVT)**
(DURATION: 1 YEAR/2 YEARS)

**NSQ
COMPLIANT
TRAINING
PROGRAMMES**
(DURATION: FROM 1200 HOURS
TO 90 HOURS)

**NSQ
EXEMPTED
TRAINING
PROGRAMMES**
(DURATION: 96 HOURS/
1 MONTH)

**NSQ
NON - EXEMPTED
TRAINING
PROGRAMMES**
(DURATION: 96 HOURS/
1 MONTH)

CONTENTS

ITI TRADES (AFFILIATED BY NCVET/SCVT)

Sl. No.	Name of the Trade	NSQF Level	Duration	Entry Qualification	Page No.
01	Machinist (Affiliated by NCVET)	4	2400 Hours/2 Years	10th Std. Pass	1
02	Turner (Affiliated by NCVET)	4	2400 Hours/2 Years	10th Std. Pass	1
03	Welder (Affiliated by NCVET)	3	1200 Hours/1 Year	8th Std. Pass	2
04	Machinist (Affiliated By SCVT)	4	2400 Hours/2 Years	10th Std. Pass	2
05	Fitter (Affiliated By SCVT)	4	2400 Hours/2 Years	10th Std. Pass	3
06	Electrician (Affiliated by SCVT)	4	2400 Hours/2 Years	10th Std. Pass	3
07	Computer Operator and Programming Assistant (COPA) (Affiliated By SCVT)	3	1200 Hours/1 Year	10th Std. Pass	4

CONTENTS

NSQF COMPLIANT TRAINING PROGRAMMES

Sl. No.	Name of the Training Programme	NSQF Level	Duration	Entry Qualification	Page No.
01	Asst. Operator – Conventional Machines	2.5	1200 Hours/1 Year	8th Std. Pass or Above	5
02	Asst. Operator – CNC Milling (Tool Room)	3	600 Hours/6 Months	10th Std. Pass or Above	5
03	Asst. Operator – CNC Turning (Tool Room)	3	600 Hours/6 Months	10th Std. Pass or Above	6
04	Jr. Technician - Inspection & Quality Control	3	600 Hours/6 Months	10th Std. Pass or Above	6
05	Assistant Electrician (Domestic cum Industrial)	3	600 Hours/6 Months	10th Std. Pass or Above	7
06	Jr. Technician – Welding	3	600 Hours/6 Months	10th Std. Pass or Above	7
07	3D Animator Assistant	3	600 Hours/6 Months	10th Std. Pass or Above	8
08	Graphic Designer Assistant	3	390 Hours/4 Months	10th Std. Pass or Above	8
09	Jr. Technician (Computer Hardware & Network)	3	360 Hours/3 Months	10th Std. Pass or Above	9
10	Technician (Computer Hardware & Network Management)	4.5	600 Hours/6 Months	12th Std. Pass or Above	9
11	Graphics & Web Designer Assistant	4	600 Hours/6 Months	12th Std. Pass or Above	10
12	Technician - Room Air Conditioner & Home Appliances	4	600 Hours/6 Months	12th Std. Pass or Above	10
13	VFX Associate	4	600 Hours/6 Months	12th Std. Pass or Above	11

CONTENTS

NSQF COMPLIANT TRAINING PROGRAMMES

Sl. No.	Name of the Training Programme	NSQF Level	Duration	Entry Qualification	Page No.
14	Multimedia and Animation Associate	4	600 Hours/6 Months	12th Std. Pass or Above	11
15	CISCO Certified Network Associate	4	480 Hours/5 Months	12th Std. Pass or Above	12
16	Assistant Drone Technician	3	420 Hours/4 Months	10 th Std Pass or Above	12
17	Jr. Web Designer	4	390 Hours/4 Months	12th Std. Pass or Above	13
18	Assistant Tool Maker	4	1200 Hours/1 Year	ITI/12th Std. Pass or Above	14
19	Solar PV Installer (Suryamitra)	4	420 Hours/4 Months	10 th Std Pass or Above	15
20	Cloud Computing Assistant	3	300 Hours/3 Months	10th Std. Pass or Above	15
21	Full-Stack Developer	4.5	600 Hours/6 Months	12th Std. Pass or above	16
22	Associate Developer AR VR	4.5	600 Hours/6 Months	12th Std. Pass or above	17
23	Technician-Hand Held Products	4	510 Hours/4 Months	12th Std. Pass or above	17
24	Fundamentals of SAP Business One	5.5	90 Hours/1 Month	12th Std. Pass or above	18
25	Artificial Intelligence Application Developer	4.5	540 Hours/5 Months	Any Degree/Diploma in Engineering	18
26	Advanced Certificate Course in Software and Application	-	600 Hours/6 Months	Degree, Diploma or any Graduate	19
27	Technician - CNC Machining	4	600 Hours/6 Months	10th Std. Pass with ITI/12th Std. Pass or Above	19
28	Project Coordinator (Construction)	5.5	1200 Hours/1 Year	Degree/Diploma in Civil Engineering & Its Equivalent	20
29	Front Line Junior Supervisor (Construction)	4.5	600 Hours/6 Months	Degree/Diploma in Civil Engineering & Its Equivalent	21
30	Jr. Designer - CAD/CAM	4.5	600 Hours/6 Months	Diploma in Mechanical/Production/Automobile Engineering & Its Equivalent	21
31	CNC Programmer - Tool Room	4.5	600 Hours/6 Months	Diploma in Mechanical Engineering & Its Equivalent	22
32	Jr. Designer - Tool	4.5	600 Hours/6 Months	Diploma in Mechanical Engineering & Its Equivalent	23
33	Technical Supervisor - Additive Manufacturing	5	600 Hours/6 Months	Degree/Diploma in Mechanical Engineering & Its Equivalent	23

CONTENTS

NSQF COMPLIANT TRAINING PROGRAMMES

Sl. No.	Name of the Training Programme	NSQF Level	Duration	Entry Qualification	Page No.
34	Sr. Technician - Machine Maintenance and Automation	4.5	600 Hours/6 Months	Diploma in Electrical/Electronics/Mechatronics, Mechanical Engineering & Its Equivalent	24
35	Jr. Embedded Developer	4.5	600 Hours/6 Months	Diploma in Electrical/Electronics/Mechatronics Engineering & Its Equivalent	24
36	Certificate Course in Machining	-	600 Hours/6 Months	ITI in Machinist/Fitter/Turner	25

CONTENTS

NSQF EXEMPTED TRAINING PROGRAMMES

Sl. No.	Name of the Training Programme	Duration	Entry Qualification	Page No.
01	AutoCAD	96 Hours/1 Month	10th Std. Pass or Above	26
02	Creo Parametric			26
03	Delcam			26
04	CATIA			26
05	Solid Works			27
06	Ansys			27
07	Mastercam			27
08	Unigraphics (NX)			27
09	3D Printing			28
10	CNC Programming on Lathe			28
11	CNC Machining on Lathe			28
12	CNC Programming on Milling			28
13	CNC Machining on Milling			29
14	STAAD Pro			29
15	3Ds Max			30
16	Revit Architecture			30
17	PLC Programming			30
18	VLSI			31
19	Electrical CAD			31
20	Embedded System			31
21	SCADA			32
22	MATLAB			32
25	Computer Hardware & Networking			33
26	JAVA			33

CONTENTS

NSQF NON - EXEMPTED TRAINING PROGRAMMES

Sl. No.	Name of the Training Programme	Duration	Entry Qualification	Page No.
01	Suryamitra (Solar PV Installation)	96 Hours/1 Month	10th Std. Pass or Above	33
02	Hydraulics & Pneumatics			34
03	LabVIEW			34
04	Survey & GIS			34
05	Electrical Machine Lab			35
06	Python Programming			35
07	Artificial Intelligence & Machine Learning			35
08	Core Java			36
09	SAP Business One			36
10	Programming in C/C++			36
11	Internet of Things (IoT)			37
12	Server Administration			37
13	Graphic Designing			37
14	Web Designing & Developing			38
15	2D Animator			38
16	Soft Skills			38
17	Entrepreneurship Skill Development Programme	One Week	39	

ITI TRADES (AFFILIATED BY NCVET)

1 Machinist

Affiliated by NCVET

Duration:	2 Years
Eligibility	10th Std. Pass
Selection Procedure	As per norms of DE&CT, Assam
Intake Capacity	40 Nos.
Course Contents	As per NCVET Syllabus
Course Starts on	September/October
Course Fee	Rs. 26,000 (Per Year)



For General/OBC Candidate

- An amount of ₹18,000/- is to be paid at the time of Admission. This covers Registration, Administration and Fees for One Semester.
- The remaining amount is to be paid in Three Installments.

For SC/ST Candidate

- An amount of ₹5,000/- is to be paid at the time of Admission. This covers Registration & Administration fees.
- No Semester Fees for SC/ST Candidate only.

2 Turner

Affiliated by NCVET

Duration:	2 Years
Eligibility	10th Std. Pass
Selection Procedure	As per norms of DE&CT, Assam
Intake Capacity	40 Nos.
Course Contents	As per NCVET Syllabus
Course Starts on	September/October
Course Fee	Rs. 26,000 (Per Year)



For General/OBC Candidate

- An amount of ₹18,000/- is to be paid at the time of Admission. This covers Registration, Administration and Fees for One Semester.
- The remaining amount is to be paid in Three Installments.

For SC/ST Candidate

- An amount of ₹5,000/- is to be paid at the time of Admission. This covers Registration & Administration Fees.
- No Semester Fees for SC/ST Candidate only.

ITI TRADES (AFFILIATED BY NCVET)

3 Welder

Affiliated by NCVET

Duration:	1 Year
Eligibility	8th Std. Pass
Selection Procedure	As per norms of DE&CT, Assam
Intake Capacity	80 Nos.
Course Contents	As per NCVET Syllabus
Course Starts on	September/October
Course Fee	Rs. 26,000



For General/OBC Candidate

- An amount of ₹18,000/- is to be paid at the time of Admission. This covers Registration, Administration and Fees for One Semester.
- The remaining amount is to be paid in Three Installments.

For SC/ST Candidate

- An amount of ₹5,000/- is to be paid at the time of Admission. This covers Registration & Administration Fees.
- No Semester Fees for SC/ST Candidate only.

ITI TRADES (AFFILIATED BY SCVT)

4 Machinist

Affiliated by SCVT

Duration:	2 Years
Eligibility	10th Std. Pass
Selection Procedure	As per norms of DE&CT, Assam
Intake Capacity	20 Nos.
Course Contents	As per SCVT Syllabus
Course Starts on	September/October
Course Fee	Rs. 26,000 (Per Year)



For General/OBC Candidate

- An amount of ₹18,000/- is to be paid at the time of Admission. This covers Registration, Administration and Fees for One Semester.
- The remaining amount is to be paid in Three Installments.

For SC/ST Candidate

- An amount of ₹5,000/- is to be paid at the time of Admission. This covers Registration & Administration Fees.
- No Semester Fees for SC/ST Candidate only.

ITI TRADES (AFFILIATED BY SCVT)

5 Fitter

Affiliated by SCVT

Duration:	2 Years
Eligibility	10th Std. Pass
Selection Procedure	As per norms of DE&CT, Assam
Intake Capacity	20 Nos.
Course Contents	As per SCVT Syllabus
Course Starts on	September/October
Course Fee	Rs. 26,000 (Per Year)



For General/OBC Candidate

- An amount of ₹18,000/- is to be paid at the time of Admission. This covers Registration, Administration and Fees for One Semester.
- The remaining amount is to be paid in Three Installments.

For SC/ST Candidate

- An amount of ₹5,000/- is to be paid at the time of Admission. This covers Registration & Administration Fees.
- No Semester Fees for SC/ST Candidate only.

6 Electrician

Affiliated by SCVT

Duration:	2 Years
Eligibility	10th Std. Pass
Selection Procedure	As per norms of DE&CT, Assam
Intake Capacity	20 Nos.
Course Contents	As per SCVT Syllabus
Course Starts on	September/October
Course Fee	Rs. 26,000 (Per Year)



For General/OBC Candidate

- An amount of ₹18,000/- is to be paid at the time of Admission. This covers Registration, Administration and Fees for One Semester.
- The remaining amount is to be paid in Three Installments.

For SC/ST Candidate

- An amount of ₹5,000/- is to be paid at the time of Admission. This covers Registration & Administration Fees.
- No Semester Fees for SC/ST Candidate only.

ITI TRADES (AFFILIATED BY SCVT)

7

Computer Operator and Programming Assistant (COPA)

Affiliated by SCVT

Duration:	1 Year
Eligibility	10th Std. Pass
Selection Procedure	As per norms of DE&CT, Assam
Intake Capacity	48 Nos.
Course Contents	As per SCVT Syllabus
Course Starts on	September/October
Course Fee	Rs. 12,000



For General/OBC Candidate

- An amount of ₹11,000/- is to be paid at the time of Admission. This covers Registration, Administration and Fees for One Semester.
- The remaining amount is to be paid in One Installment.

For SC/ST Candidate

- An amount of ₹5,000/- is to be paid at the time of admission. This covers Registration & Administration Fees.
- No Semester Fees for SC/ST Candidate only.

TRTC
GUWAHATI

COURSES FOR 8th PASS & ABOVE STUDENTS

1 Asst. Operator – Conventional Machines

NSQF Level: 2.5

Objectives

After completion of the course, the trainee will be able to Operate Conventional Machines (Lathe, Milling, Grinding, Drilling), Read the Drawing to produce the job on a Machine Measure Dimensions using Linear Measuring Instruments.

Job Role

Operator - Conventional Machine

Duration

1200 Hours/1 Year

Course Content

Carry out Basic Machining Operation on Conventional Machine, Read Simple Part Drawing, Perform Basic Mathematical Calculation for Machining, Carry out Advance Machining Operation on Conventional Machine, Employability Skill.



Mode of Selection

First come, First Serve Basis

Course Fee

Rs. 24,000/- (No Course fee for SC/ST Category Candidate)

Course Starts on

April, July, October & January

- Rs. 500/- extra for Assessment & Examination Fee.
- A Registration Fee of Rs. 1000/- is payable in advance.
- The remaining amount is to be paid in two installments.

COURSES FOR HSC/SSC & ABOVE STUDENTS

2 Asst. Operator – CNC Milling (Tool Room)

NSQF Level: 3

Objectives

After completion of course, the trainee will be able to be expertise in operating cum setting of CNC Milling Machine, to get an employment in Engineering/Manufacturing Industries, to become an Entrepreneur.

Job Role

Technician - CNC Milling

Duration

600 Hours/6 Months

Course Content

Assist in Operation of CNC Milling Machine, Demonstrate the Working Principle of Machine Tools, Checking Dimensions of CNC Machined Part, Create Part Drawing using AutoCAD, Employability Skills, OJT.



Mode of Selection

First come, First Serve Basis

Course Fee

Rs. 24,000/- (No Course fee for SC/ST Category Candidate)

Course Starts on

April, July, October & January

- Rs. 500/- extra for Assessment & Examination Fee.
- A Registration Fee of Rs. 1000/- is payable in advance.
- The remaining amount is to be paid in two installments.

COURSES FOR HSC/SSC & ABOVE STUDENTS

3 Asst. Operator – CNC Turning (Tool Room)

NSQF Level: 3

Objectives

After completion of the course, the trainee will be able to expertise in CNC Lathe Operating cum setting, to get an employment in Engineering/ Manufacturing Industries, to become an Entrepreneur.

Job Role

Technician - CNC Turning

Duration

600 Hours/6 Months

Course Content

Assist in Operation of CNC Lathe Machine, Demonstrate the working Principle of Machine Tools, Checking dimensions of CNC machined Part, Create Part Drawing using AutoCAD, Employability Skills.

Mode of Selection

First come, First Serve Basis

Course Fee

Rs. 24,000/- (No Course fee for SC/ST Category Candidate)

Course Starts on

April, July, October & January

- Rs. 500/- extra for Assessment & Examination Fee.
- A Registration Fee of Rs. 1000/- is payable in advance.
- The remaining amount is to be paid in two installments.



4 Jr. Technician - Inspection & Quality Control

NSQF Level: 3

Objectives

After completion of course, the trainee will be able to competent in Inspection and Quality Control and get a job as Quality Control Inspector/Quality Controller in Manufacturing Sector/Industry, qualified trainee who attain the above skill can also become an Entrepreneur.

Job Role

Technician - Inspection & Quality Control

Duration

600 Hours/6 Months

Course Content

Create Part Drawing using AutoCAD, Demonstrate the Working Principle of Machine Tools, Assistant in Checking & Inspection of Part, Employability Skill.

Mode of Selection

First come, First Serve Basis

Course Fee

Rs. 24,000/- (No Course fee for SC/ST Category Candidate)

Course Starts on

April, July, October & January

- Rs. 500/- extra for Assessment & Examination Fee.
- A Registration Fee of Rs. 1000/- is payable in advance.
- The remaining amount is to be paid in two installments.



COURSES FOR HSC/SSC & ABOVE STUDENTS

5 Assistant Electrician (Domestic cum Industrial)

NSQF Level: 3

Objectives

After completion of the course, the trainee will be able to carry out Electrical Installation, Maintenance at Domestic and Industrial Site. Learned trainee is qualified to work as Assistant Electrician. Qualified trainee can also start their own electrical workshop or choose to be an Entrepreneur.

Job Role

Assistant Electrician

Duration

600 Hours/6 Months

Course Content

Acquire the concepts of Basic Electrical, Measure Electrical Parameters (Voltage, Current, Power etc.), Prepare for Domestic and Industrial Electrical Wiring, Perform Transformer Testing and Maintenance, Power Equipment Testing and Maintenance, Repair and Maintenance of Electrical Machines, Employability Skills.

Mode of Selection

First come, First Serve Basis

Course Fee

Rs. 24,000/- (No Course fee for SC/ST Category Candidate)

Course Starts on

April, July, October & January

- Rs. 500/- extra for Assessment & Examination Fee.
- A Registration Fee of Rs. 1000/- is payable in advance.
- The remaining amount is to be paid in two installments.



6 Jr. Technician - Welding

NSQF Level: 3

Objectives

After completion of course, the trainee will be able to understand the various Welding Methods, Perform Welding Operation on different Materials with selection of appropriate Welding Methods, Read Basic Engineering Drawings for Welding Operation, get an employment in Engineering/Manufacturing and also become an Entrepreneur.

Job Role

Technician - Welding

Duration

600 Hours/6 Months

Course Content

Interpret Engineering Drawing, Perform Machining Operation on Conventional Machine, Carry out Welding Operations (Arc and Gas Welding), Employability Skills.

Mode of Selection

First come, First Serve Basis

Course Fee

Rs. 24,000/- (No Course fee for SC/ST Category Candidate)

Course Starts on

April, July, October & January

- NOTE :** Rs. 500/- extra for Assessment & Examination Fee.
A Registration Fee of Rs. 1000/- is payable in advance.
The remaining amount is to be paid in two installments.



COURSES FOR HSC/SSC & ABOVE STUDENTS

7 3D Animator Assistant

NSQF Level: 3

Objectives

After completion of the course, the trainee will be able to Create Visual Design in 3D software, Add Texturing, Lighting & Rendering process in Created models, Create Character Animation, Edit the created animation video clip, Qualified trainee to get a job in Photo Studio, Advertising/Media Company or become an Entrepreneur.

Job Role

3D Animator

Duration

600 Hours/6 Months

Course Content

Understand concepts to create Computer Graphics, Gain in-depth knowledge to create 3D Models, Gain Knowledge to Texture, add Lights and Render 3D file, Gain In-depth knowledge to Animate a 3D Character, Understand the Fundamentals of Video Editing, Employability Skill.

Mode of Selection

First come, First Serve Basis

Course Fee

Rs. 30,000/- (No Course fee for SC/ST Category Candidate)

Course Starts on

April, July, October & January

NOTE : Rs. 500/- extra for Assessment & Examination Fee.

A Registration Fee of Rs. 1000/- is payable in advance.

The remaining amount is to be paid in two installments.

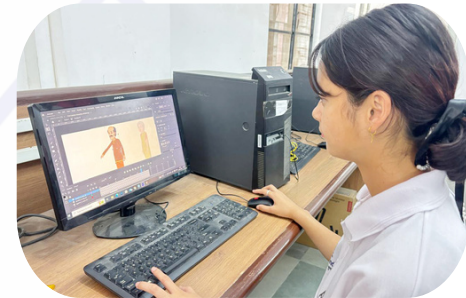

8 Graphic Designer Assistant

NSQF Level: 3

Objectives

After completion of course, the trainee will be able to create a Conceptual Art, using the Illustrator Software create a Graphics & Modify according to creative head. Qualified trainee to get a job in Photo Studio, Advertising/Media Company or become an Entrepreneur.

Job Role

Jr. Graphic Designer

Duration

390 Hours/4 Months

Course Content

Basic Understanding of Concept Art, Attain knowledge of Computer Illustrations, Gain insight into Computer Graphics, Employability Skills.

Mode of Selection

First come, First Serve Basis

Course Fee

Rs. 24,000/- (No Course fee for SC/ST Category Candidate)

Course Starts on

April, July, October & January

NOTE : Rs. 500/- extra for Assessment & Examination Fee.

A Registration Fee of Rs. 1000/- is payable in advance.

The remaining amount is to be paid in two installments.



COURSES FOR HSC/SSC & ABOVE STUDENTS

9 Jr. Technician (Computer Hardware & Network)

NSQF Level: 3

Objectives

After completion of the course, the trainee will be able to Repair and Maintain Computer Hardware System, Install and Configure the Computer and Network Devices, Troubleshoots the systems such as Printers, Scanners and Network Devices. Get the employment in the field of Computer & Hardware Maintenance and also become an Entrepreneur.

Job Role

Technician (Computer Hardware & Networking)

Duration

360 Hours/3 Months

Course Content

Understand Basic Electronics & its Repairs, Install Computer Peripherals & their Maintenance, Operates System Software Installation, Monitoring Network Setup & their Maintenance, Employability Skill.

Mode of Selection

First come, First Serve Basis

Course Fee

Rs. 24,000/- (No Course fee for SC/ST Category Candidate)

Course Starts on

April, July, October & January

NOTE : Rs. 500/- extra for Assessment & Examination Fee.

A Registration Fee of Rs. 1000/- is payable in advance.

The remaining amount is to be paid in two installments.



10 Technician - Computer Hardware & Network Management

NSQF Level: 4

Objectives

After completion of course, the trainee will be able to take care of the Maintenance & Troubleshooting of Computer Hardware & Networking, Assemble & Disassemble the Computer as well as Install various types of Software and Fault Tolerant Solutions, Setup Server Network and Share the Data, Manage various Operating System.

Job Role

Supervisor

Duration

600 Hours/6 Months

Course Content

Prepare Testing & Maintenance of Power Supply-SMPS, Assembly of PC Architecture & their Troubleshooting, Installing System Software & their Maintenance, Managing Network & Windows Server Configuration, Understand & Operate LINUX Operating System & its Management, Employability Skill.

Mode of Selection

First come, First Serve Basis

Course Fee

Rs. 24,000/- (No Course fee for SC/ST Category Candidate)

Course Starts on

April, July, October & January

NOTE : Rs. 500/- extra for Assessment & Examination Fee.

A Registration Fee of Rs. 1000/- is payable in advance.

The remaining amount is to be paid in two installments.



COURSES FOR HSC/SSC & ABOVE STUDENTS

11 Graphics & Web Designer Assistant

NSQF Level: 4

Objectives	After completion of the course, the trainee will be able to perform Computer Generated Imagery, UI Design, UX Design, Website Designing, Front-End & Back-End Development, qualified trainee is competent to get an employment in Media and Entertainment sector, qualified trainee will become an Entrepreneur.
Job Role	Mid - Level Graphics & Web Designer
Duration	600 Hours/6 Months
Course Content	Mastering the fundamentals of Art and Illustration, Acquire proficiency in Computer Graphics, Understand and develop a website, Understanding to Work with Figma & Adobe XD, Employability Skill.
Mode of Selection	First come, First Serve Basis
Course Fee	Rs. 24,000/- (No Course fee for SC/ST Category Candidate)
Course Starts on	April, July, October & January

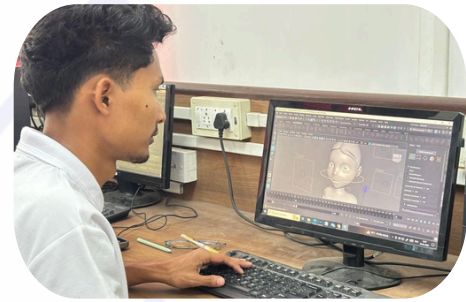

NOTE : Rs. 500/- extra for Assessment & Examination Fee.
A Registration Fee of Rs. 1000/- is payable in advance.
The remaining amount is to be paid in two installments.

12 Technician - Room Air Conditioner & Home Appliances

NSQF Level: 4

Objectives	After completion of course, the trainee will be able to Installation, Repairing & Servicing of AC/Refrigerator/Washing Machine & Microwave Oven, Refrigeration and Air Conditioner Mechanic in Domestic, Ice Factory, Cold Storage Plants, specialized Air Conditioning Units or Refrigeration, Air Conditioner Industries, to become an Entrepreneur.
Job Role	Sr. Technician
Duration	600 Hours/6 Months
Course Content	Study on Basic Electrical/Electronics, Safety & Hand Tools - RACHA, Advance Skill Enhancement on Troubleshooting, Assembly, Disassembly, Installation & Demonstration on respective Products -RACHA, Employability Skills, On Job Training.
Mode of Selection	First come, First Serve Basis
Course Fee	Rs. 24,000/- (No Course fee for SC/ST Category Candidate)
Course Starts on	April, July, October & January



NOTE : Rs. 500/- extra for Assessment & Examination Fee.
A Registration Fee of Rs. 1000/- is payable in advance.
The remaining amount is to be paid in two installments.

COURSES FOR HSC/SSC & ABOVE STUDENTS

13 VFX Associate

NSQF Level: 4

Objectives

After completion of the course, the trainee will be able to create Stunning and Realistic 3D Animations and Visual Effects for various mediums such as Films, Television Shows, Video Games, Virtual Reality (VR) and Advertisements, Trainee who attain this qualification can perform 3D Animation,, Character Animation, Game Creation, Visualization in VR, and Special Effects in Film, Tv Shows etc., qualified trainee are competent to get an employment in Media and Entertainment sector as per the requirement, qualified trainee will become an Entrepreneur.

Job Role

VFX Supervisor

Duration

600 Hours/6 Months

Course Content

Understand and Create Computer Graphics, Attain knowledge to create 3D Model, Texture and Light, Gain Knowledge to Animate a 3D Character and Apply FX, Basic Understanding of Video Editing & Compositing, Understanding to use 3D Models in VR Environment, Employability Skill.

Mode of Selection

First come, First Serve Basis

Course Fee

Rs. 30,000/- (No Course fee for SC/ST Category Candidate)

Course Starts on

April, July, October & January

NOTE : Rs. 500/- extra for Assessment & Examination Fee.

A Registration Fee of Rs. 1000/- is payable in advance.

The remaining amount is to be paid in two installments.



14 Multimedia and Animation Associate

NSQF Level: 4

Objectives

After completion of course, the trainee will be able to perform 3D Animation, Character Animation, Game Creation, Visualization in VR, and Special Effects in Film, Tv Shows etc., qualified trainee is competent to get an employment in Media and Entertainment sector, qualified trainee will become an Entrepreneur.

Job Role

Multimedia and Animation Assistant Manager

Duration

600 Hours/6 Months

Course Content

Understand FX & Create Motion Graphics, Understand to create 3D Models and Apply Textures, Gain knowledge to Animate a 3D Character, Attain Knowledge to Create User Interfaces, Employability Skill.

Mode of Selection

First come, First Serve Basis

Course Fee

Rs. 30,000/- (No Course fee for SC/ST Category Candidate)

Course Starts on

April, July, October & January

NOTE : Rs. 500/- extra for Assessment & Examination Fee.

A Registration Fee of Rs. 1000/- is payable in advance.

The remaining amount is to be paid in two installments.



COURSES FOR HSC/SSC & ABOVE STUDENTS

15 CISCO Certified Network Associate

NSQF Level: 4

Objectives	After completion of the course, the trainee will be able to perform Computer Networks, various protocols used in Communication, Managing and configuring Cisco Switches and Routers and various WAN Technologies, Manage Network for an Organization, Install, Configure, Operate, and Troubleshoot medium-sized Routed and Switched Networks, trainee is competent to get the employment in the IT Industries and also become an Entrepreneur.
Job Role	Technician Network Support
Duration	480 Hours/4 Months
Course Content	Introduction to Networks, Switching, Routing, and Wireless Essentials, Enterprise Networking, Security, and Automation, Employability Skill.
Mode of Selection	First come, First Serve Basis
Course Fee	Rs. 24,000/- (No Course fee for SC/ST Category Candidate)
Course Starts on	April, July, October & January



NOTE : Rs. 500/- extra for Assessment & Examination Fee.
A Registration Fee of Rs. 1000/- is payable in advance.
The remaining amount is to be paid in two installments.

COURSES FOR HSC/SSC & ABOVE STUDENTS

16 Assistant Drone Technician

NSQF Level: 3

Objectives	After completion of course, the trainee will be able to conducts routine Maintenance, Troubleshoots, Bench Testing and Flying while ensuring adherence to standard working practices. The individuals in this job maintain, troubleshoots, test and fly drones of varying sizes that are used for various applications such as aerial photography & videography, transporting goods, firefighting, survey and mapping, powerline Inspection, Industrial Inspection, Emergency Operations etc.
Job Role	Drone Service Technician/Drone Manufacturing & Assembly Technician
Duration	420 Hours/4 Months



COURSES FOR HSC/SSC & ABOVE STUDENTS

- Course Content** → Theoretical Concept of Drone, Practical Aspect of Drones and Simulation Techniques, Drone Testing & Maintenance, Work Effectively at the Workplace, Employability Skills.
- Mode of Selection** → First come, First Serve Basis
- Course Fee** → Rs. 30,000/- (No Course fee for SC/ST Category Candidate)
- Course Starts on** → April, July, October & January



NOTE : Rs. 500/- extra for Assessment & Examination Fee.
 A Registration Fee of Rs. 1000/- is payable in advance.
 The remaining amount is to be paid in two installments.

COURSES FOR HSC/SSC & ABOVE STUDENTS

17 Jr. Web Designer

NSQF Level: 4

- Objectives** → After completion of course, the trainee will be able to create and manage content for websites, Trainee will work on Web Technologies such as HTML, CSS, and JavaScript for Front-End Development.
- Job Role** → Web Designer
- Duration** → 390 Hours/4 Months
- Course Content** → Understand the Fundamentals of Web Technologies, Acquire the Concepts of UI/UX design tools like Figma & Adobe XD, Employability Skill.
- Mode of Selection** → First come, First Serve Basis
- Course Fee** → Rs. 24,000/- (No Course fee for SC/ST Category Candidate)
- Course Starts on** → April, July, October & January



NOTE : Rs. 500/- extra for Assessment & Examination Fee.
 A Registration Fee of Rs. 1000/- is payable in advance.
 The remaining amount is to be paid in two installments.

COURSES FOR HSC WITH ITI/SSC & ABOVE STUDENTS

18 Assistant Tool Maker

NSQF Level: 4

Objectives	After completion of the course, the trainee will be able to work on Conventional, Non-Conventional, special purpose machines. Design and manufacture of simple press tools, jigs and fixtures. Generate CAM programs. The subjects covered in this programme are - Press Tool Technology, Mould technology, CAD/CAM, CNC Technology, Production technology, Metrology, Jigs and Fixtures, Material Technology and Heat Treatment, Strength of Materials, Tool design drawing, Work shop practice, Employability skills.
Job Role	Process Engineer/Product Design Engineer Tool Designer/Digital Manufacturing Engineer
Duration	1200 Hours/1 Year
Course Content	Production Technology-3, Metrology-3, Material technology and Heat Treatment, Press Tool Technology-1, Jigs and Fixtures, Strength of Materials-1, CAD Fusion 360 Lab, Tool Design Drawing-1, Workshop Practical, Employability Skill, Mould Technology-1, Production Technology-4, Strength of Material-2, Press Tool Technology-2, CNC Technology, Tool Design Drawing-2, Workshop Practical, CAD/CAM-1, Employability Skill, OJT.
Mode of Selection	First come, First Serve Basis
Course Fee	Rs. 40,000/- (No Course fee for SC/ST Category Candidate)
Course Starts on	April, July, October & January



NOTE : Rs. 500/- extra for Assessment & Examination Fee.
A Registration Fee of Rs. 1000/- is payable in advance.
The remaining amount is to be paid in two installments.

COURSES FOR HSC WITH ITI/SSC & ABOVE STUDENTS

19 Solar PV Installer (Suryamitra)

NSQF Level: 4

Objectives	After completion of the course, the trainee will be able to perform Solar PV Installer Checks, Adapts, Implements, Configures, Installs, Inspects, Tests and Commissions different Components of Photovoltaic Systems, that meet the performance and reliability needs of customers by incorporating quality craftsmanship and complying with all applicable codes, standards and safety requirements.
Job Role	Solar Photovoltaic Entrepreneur/Solar PV Junior Engineer
Duration	420 Hours/4 Months
Course Content	Site survey for installation of solar PV system, Procure Solar PV system components, Install civil and mechanical parts of Solar PV system, Installation of electrical components of a solar PV system, Test and commission Solar PV system, Maintain Solar Photovoltaic Power System, Maintain Personal Health & Safety at project site, Customer orientation for Solar PV System, Employability Skills, On the Job Training.
Mode of Selection	First come, First Serve Basis
Course Fee	Rs. 24,000/- (No Course fee for SC/ST Category Candidate)
Course Starts on	April, July, October & January



NOTE : Rs. 500/- extra for Assessment & Examination Fee.
A Registration Fee of Rs. 1000/- is payable in advance.
The remaining amount is to be paid in two installments.

COURSES FOR HSC & ABOVE STUDENTS

20 Cloud Computing Assistant

NSQF Level: 3

Objectives	After completion of the course, the trainee will be able to grasp the complete concept of Cloud Computing from a "Hands-On" Point of View. The learner will be made aware of the concept of virtualization and as a "Cloud Computing Assistant" would possess the basic skillset to practically implement the concept of virtualisation with an apt exposure to the Linux operating System. With the inclusion of Google Open Source Services, the usage of Software as a Service fundamentals will also be taught to the enrolled trainees.
-------------------	--

COURSES FOR HSC & ABOVE STUDENTS

Job Role	Cloud Administrator/Cloud Architect/Cloud Consultant
Duration	300 Hours/3 Months
Course Content	Conceptualise Operating Systems (Windows and Linux), Introduction to Network Management, Implementing Virtualization and Basics of Cloud Computing, Employability Skills, OJT/Project.
Mode of Selection	First come, First Serve Basis
Course Fee	Rs. 24,000/- (No Course fee for SC/ST Category Candidate)
Course Starts on	April, July, October & January



NOTE : Rs. 500/- extra for Assessment & Examination Fee.
 A Registration Fee of Rs. 1000/- is payable in advance.
 The remaining amount is to be paid in two installments.

COURSES FOR HSC & ABOVE STUDENTS

21 Full-Stack Developer

NSQF Level: 4.5

Objectives	After completion of the course trainees will be able to create backend & front end programs to develop the website, trainees are capable to support in designing, installing and maintaining the software systems, trainees are capable in writing the programs for different application, trainees are competent in getting employment in IT industries or also become an entrepreneur.
Job Role	Web Developer
Duration	600 Hours/6 Months
Course Content	Understanding the Concepts of C and Python Programming, Gaining knowledge in Oracle and MySQL Database Management System, Working Back-End design with Spring Boot & Hibernate Framework, Mastering UI design with Angular, Deploying & Hosting Application with Docker & Kubernetes, Employability Skill.
Mode of Selection	First come, First Serve Basis
Course Fee	Rs. 30,000/- (No Course fee for SC/ST Category Candidate)
Course Starts on	April, July, October & January

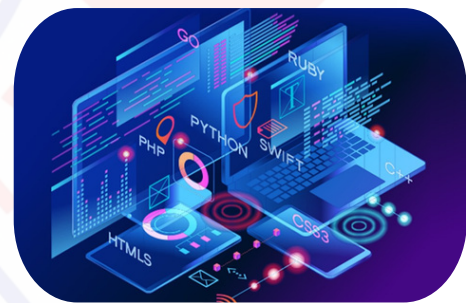

NOTE : Rs. 500/- extra for Assessment & Examination Fee.
 A Registration Fee of Rs. 1000/- is payable in advance.
 The remaining amount is to be paid in two installments.

COURSES FOR HSC & ABOVE STUDENTS

22 Associate Developer AR VR

NSQF Level: 4.5

Objectives	After completion of the course trainees will be expertise in AR & VR Applications, to get an employment in Media & Entertainment Industries, to become an entrepreneur.
Job Role	Assistant Manager
Duration	600 Hours/6 Months
Course Content	Understand and Create Computer Graphics, Acquire Knowledge to Develop an VR Application, Acquire Knowledge to Develop an AR Application and Employability Skills.
Mode of Selection	First come, First Serve Basis
Course Fee	Rs. 30,000/- (No Course fee for SC/ST Category Candidate)
Course Starts on	April, July, October & January



NOTE : Rs. 500/- extra for Assessment & Examination Fee.
A Registration Fee of Rs. 1000/- is payable in advance.
The remaining amount is to be paid in two installments.

COURSES FOR HSC & ABOVE STUDENTS

23 Technician-Hand Held Products

NSQF Level: 4

Objectives	After completion of the course trainees will be able to rectify the faults in the Hand-Held Products like Mobile, Tablet, Laptop, performs front end or hardware level repair as required, resolves software issues and ensures effective functioning before delivering back to customer, to become an entrepreneur.
Job Role	Cloud Administrator/Cloud Architect/Cloud Consultant
Duration	510 Hours/3 Months
Course Content	Study on Basic Electrical/Electronics, Safety & Hand Tools-HHP, Advance Skill Enhancement on Troubleshooting, Assembly, Disassembly & Set Up on Respective Products-HHP, Employability Skills.
Mode of Selection	First come, First Serve Basis
Course Fee	Rs. 22,000/- (No Course fee for SC/ST Category Candidate)
Course Starts on	April, July, October & January

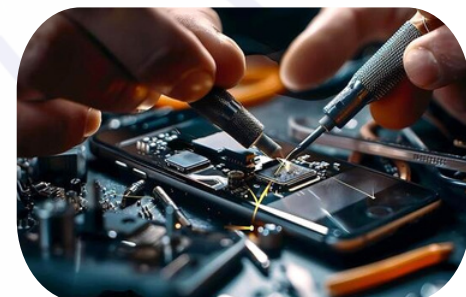

NOTE : Rs. 500/- extra for Assessment & Examination Fee.
A Registration Fee of Rs. 1000/- is payable in advance.
The remaining amount is to be paid in two installments.

COURSES FOR ANY DEGREE/SSC & ABOVE STUDENTS

24 Fundamentals of SAP Business One

NSQF Level: 5.5

Objectives	After completion of the course trainees will be able to manage, director of a small company and want to implement a new software solution to make your business processes more efficient. He/she can able to use different tool effectively run business processes.
Job Role	Manager
Duration	90 Hours
Course Content	Fundamentals of SAP Business One
Mode of Selection	First come, First Serve Basis
Course Fee	Rs. 5,100/- (No Course fee for SC/ST Category Candidate)
Course Starts on	April, July, October & January

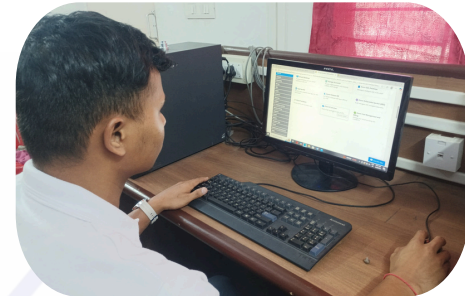

NOTE : Rs. 500/- extra for Assessment & Examination Fee.
A Registration Fee of Rs. 1000/- is payable in advance.
The remaining amount is to be paid in two installments.

COURSES FOR ANY DEGREE/DIPLOMA IN ENGINEERING

25 Artificial Intelligence Application Developer

NSQF Level: 4.5

Objectives	Fundamentals of Python programming and libraries like Numpy and pandas used for data analysis. The course will also cover Visualization with Matplotlib. The course will lay stress on developing programming skills by providing practical exposure to the aspiring Python developers and also introduce to the concepts of Machine Learning.
Job Role	Machine Learning Developer/AI Engineer/AI-Database Administrator
Duration	540 Hours/5 Months
Course Content	Programming with Python, Conceptualising Data Science with Python, Data analysis and Visualization, Fundamentals of Machine Learning, Performance and Accuracy of Machine Learning models, Fundamentals of Deep Learning, Employability Skills, OJT/Project.
Mode of Selection	First come, First Serve Basis
Course Fee	Rs. 24,000/- (No Course fee for SC/ST Category Candidate)
Course Starts on	April, July, October & January

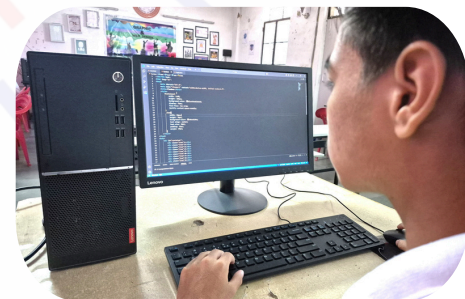

NOTE : Rs. 500/- extra for Assessment & Examination Fee.
A Registration Fee of Rs. 1000/- is payable in advance.
The remaining amount is to be paid in two installments.

COURSES FOR DIPLOMA/DEGREE/ANY GRADUATE

26 Advanced Certificate Course in Software and Application

Objectives	Prepare trainees who will be successful & professional in Industry, Government, Academics, Entrepreneurial Pursuit & Consulting Firm and apply knowledge of Computer Science.
Job Role	Software and Application Assistant / Junior Software Developer
Duration	600 Hours/6 Months
Course Content	C, C++, CORE JAVA, ORACLE, HTML, CSS, JAVASCRIPT, Advance JAVA, Project Work.
Mode of Selection	First come, First Serve Basis
Course Fee	Rs. 30,000/-
Course Starts on	April, July, October & January



NOTE : Rs. 500/- extra for Assessment & Examination Fee.
 A Registration Fee of Rs. 1000/- is payable in advance.
 The remaining amount is to be paid in two installments.

COURSES FOR HSC WITH ITI/SSC & ABOVE STUDENTS

27 Technician - CNC Machining

NSQF Level: 4

Objectives	After completion of the course, the trainee will be able to perform Machine Setup, Job Setup and Operate the Machine, perform Tool Setting as per Job requirement, Set Machining Parameters as per the requirement of Job, Get an employment in Engineering/Manufacturing Industries.
Job Role	Sr. Technician - CNC Machining
Duration	600 Hours/6 Months
Course Content	Fundamentals of CNC Technology, Create CNC Programms and carry out CNC Machining Operations, Create Part Drawing using CAD Software, Generate Part Programms using CAM Tools, Employability Skills.
Mode of Selection	First come, First Serve Basis
Course Fee	Rs. 24,000/- (No Course fee for SC/ST Category Candidate)
Course Starts on	April, July, October & January



- Rs. 500/- extra for Assessment & Examination Fee.
- A Registration Fee of Rs. 1000/- is payable in advance.
- The remaining amount is to be paid in two installments.

COURSES FOR DEGREE/DIPLOMA IN CIVIL ENGINEERING

28 Project Coordinator (Construction)

NSQF Level: 5.5

Objectives After completion of the course, the trainee will be competent in Civil Construction work and can get a job in a captive or commercial construction work or become an entrepreneur and Qualifying trainee shall be able to work in AutoCAD, STADD Pro, 3Ds Max & Sketch-Up, Estimation & Costing, Advance Survey, Soft Skill, Revit, Tekla, Arc-GIS, Primavera, Advance Road Design & Material Testing, Carry out Structural Planning & Designing, Interior & Exterior Designing, Estimation and Costing related to Constructional Work, Design Civil Constructional work by considering the strength of Civil Construction, Coordinate the Project Management in different Project Works.



Job Role Deputy Project Manager

Duration 1200 Hours/1 Year

Course Content Sketch Architectural Drawings, Section View, 3D View, Analysis of Structure & Foundation with IS Code, Design Exterior and Interior, Render, Animation with 3Ds Max & Sketch up, Create Color & Shadow in Photoshop, Estimation of building with rate analysis of Civil Works, Intro to Surveying, Leveling, Types, GPS/DGPS Function & Uses, Carry out Architectural Modeling, Exterior and Interior, Render, and Animation with Revit Detailing, Demonstrate Tekla for Steel, Concrete Structure & Bridge Design with Load Application, Create types of Topographical Map through Arc-GIS Software, Demonstrate the Project, Planning & Scheduling by using Primavera, 2D/3D Drafting including road C-Section/I-Section Design, Estimation, Explain Material Testing equipment for Soil, Aggregate, Bitumen and Steel, On Job Training.



Mode of Selection First come, First Serve Basis

Course Fee Rs. 40,000/- (No Course fee for SC/ST Category Candidate)

Course Starts on April, July, October & January

NOTE : Rs. 500/- extra for Assessment & Examination Fee.
A Registration Fee of Rs. 1000/- is payable in advance.
The remaining amount is to be paid in two installments.

COURSES FOR DEGREE/DIPLOMA IN CIVIL ENGINEERING OR IT'S EQUIVALENT

29 Front Line Junior Supervisor (Construction)

NSQF Level: 4.5

Objectives	After completion of the course the trainee competent to work in Civil Construction and can get a job in a captive or commercial construction sector or become an entrepreneur. Qualifying trainee attain skills to work in Auto CAD, STADD PRO, 3D Studio MAX, REVIT, Adobe Photoshop, GPS, DGPS Auto Level & Total Station, Estimation and Costing related Constructional Work, Design Civil Constructional Work by considering the Strength of Civil Structure.
Job Role	Project Coordinator (Construction)
Duration	600 Hours/6 Months
Course Content	Create & Modify Part Model using CAD Software, Generate Part Program Using CAM Software (CAM), Analyze Part Model, Design Surfaces using Higher end CAD Software, Generate CNC Program, Employability Skills, On Job Training.
Mode of Selection	First come, First Serve Basis
Course Fee	Rs. 30,000/- (No Course fee for SC/ST Category Candidate)
Course Starts on	April, July, October & January



NOTE : Rs. 500/- extra for Assessment & Examination Fee.
A Registration Fee of Rs. 1000/- is payable in advance.
The remaining amount is to be paid in two installments.

COURSES FOR DIPLOMA IN MECHANICAL/ PRODUCTION/AUTOMOBILE ENGINEERING & IT'S EQUIVALENT

30 Junior Designer CAD/CAM

NSQF Level: 4.5

Objectives	After completion of course, the trainee will be expertise in CAD/CAM/CAE Software Application, to get an employment in Engineering/Manufacturing Industries, to become an Entrepreneur.
Job Role	Designer - CAD/CAM
Duration	600 Hours/6 Months

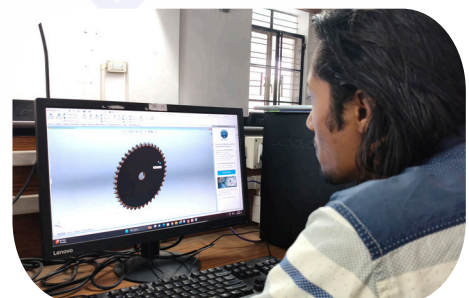

COURSES FOR DIPLOMA IN MECHANICAL ENGINEERING & IT'S EQUIVALENT

Course Content

Create & Modify Part Model using CAD Software, Generate Part Program Using CAM Software (CAM), Analyze Part Model, Design Surfaces using Higher end CAD Software, Generate CNC Program, Employability Skills, On Job Training.

Mode of Selection

First come, First Serve Basis

Course Fee

Rs. 30,000/- (No Course fee for SC/ST Category Candidate)

Course Starts on

April, July, October & January

NOTE : Rs. 500/- extra for Assessment & Examination Fee.
A Registration Fee of Rs. 1000/- is payable in advance.
The remaining amount is to be paid in two installments.

COURSES FOR DIPLOMA IN MECHANICAL ENGINEERING & IT'S EQUIVALENT

31 CNC Programmer - Tool Room

NSQF Level: 4.5

Objectives

This is an Advance Diploma programme in which trainees tend to get excellent career opportunities in the field of CNC and to upgrade professional skills of the trainees to deal with technological change. Trainees who attain this qualification are competent in CNC programming for manufacturing sector. Qualified trainees are competent to get an employment in Engineering/Manufacturing industries as per the requirement of MSMEs. Qualified trainees will become an entrepreneur

Job Role

Supervisor

Duration

600 Hours/6 Months

Course Content

Understand the Concept of Production Process, Read, Interpret and Create Part Drawing using AutoCAD, Create, Generate and Execute CNC Program for Manufacturing Process, Check and Inspect dimensions of machined Part using various Measuring Instrument, Employability Skills.

Mode of Selection

First come, First Serve Basis

Course Fee

Rs. 30,000/- (No Course fee for SC/ST Category Candidate)

Course Starts on

April, July, October & January

NOTE : Rs. 500/- extra for Assessment & Examination Fee.
A Registration Fee of Rs. 1000/- is payable in advance.
The remaining amount is to be paid in two installments.

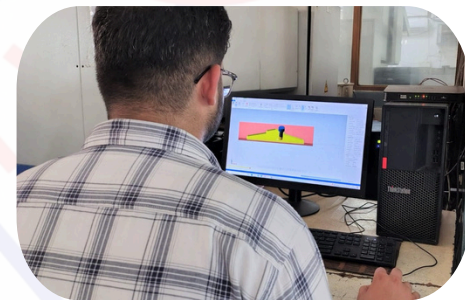

COURSES FOR DIPLOMA IN MECHANICAL ENGINEERING & IT'S EQUIVALENT

32 Jr. Designer - Tool

NSQF Level: 4.5

Objectives	The trainees who attend this qualification shall be able to assist the Sr. Tool Designer in Designing the Tool, Design and develop Tools and die with the use of high end CAD/CAM Software, Prepare the Bill of material for the Tool and Die. Get an employment in Tool Room/Manufacturing Industries/MSMEs.
Job Role	Supervisor
Duration	600 Hours/6 Months
Course Content	Create & Modify Part Model using CAD Software, Create & Modify Part Model and Generate Part Program Using CAD/ CAM Software, Design of Jigs & Fixtures, Design of Press Tools, Design of Moulds, Employability Skills.
Mode of Selection	First come, First Serve Basis
Course Fee	Rs. 30,000/- (No Course fee for SC/ST Category Candidate)
Course Starts on	April, July, October & January

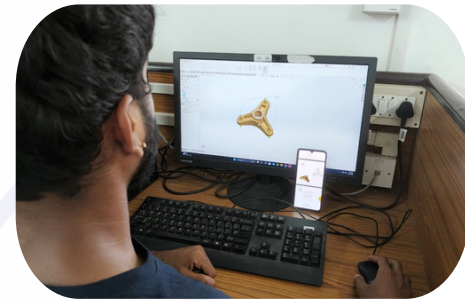

NOTE : Rs. 500/- extra for Assessment & Examination Fee.
A Registration Fee of Rs. 1000/- is payable in advance.
The remaining amount is to be paid in two installments.

COURSES FOR DEGREE/DIPLOMA IN MECHANICAL ENGINEERING & IT'S EQUIVALENT

33 Technical Supervisor - Additive Manufacturing

NSQF Level: 5

Objectives	After completion of course, the trainee will be expertise in Additive Manufacturing Application, to get an employment in Engineering/Manufacturing Industries, to become an Entrepreneur.
Job Role	Assistant Manager
Duration	600 Hours/6 Months
Course Content	Introduction to Additive Manufacturing (AM) Process, Design of Product using Design Software Tools, Develop New Product using 3D Printing Machine, Employability Skills.
Mode of Selection	First come, First Serve Basis
Course Fee	Rs. 30,000/- (No Course fee for SC/ST Category Candidate)
Course Starts on	April, July, October & January



NOTE : Rs. 500/- extra for Assessment & Examination Fee.
A Registration Fee of Rs. 1000/- is payable in advance.
The remaining amount is to be paid in two installments.

COURSES FOR DIPLOMA IN ELECTRICAL, ELECTRONICS, MECHATRONICS, MECHANICAL ENGINEERING & IT'S EQUIVALENT

34 Sr. Technician - Machine Maintenance and Automation

NSQF Level: 4.5

Objectives	After completion of course, the trainee will be able to upgrade Professional Skills of the trainee to deal with Technological Change, can perform maintenance activities for Tool Room Machines and Equipment's in MSMEs, competent to get an employment in Engineering/Manufacturing Industries.
Job Role	Supervisor
Duration	600 Hours/6 Months
Course Content	Demonstrate the Basic Machine Operation, Maintenance of Hydraulics & Pneumatics Components, Create & Modify the Electrical Circuit Diagram using CAD Software, Carry out Machine Maintenance Activities (Electrical), Basics of Industrial Automation, Employability Skills.
Mode of Selection	First come, First Serve Basis
Course Fee	Rs. 30,000/- (No Course fee for SC/ST Category Candidate)
Course Starts on	April, July, October & January



NOTE : Rs. 500/- extra for Assessment & Examination Fee.
A Registration Fee of Rs. 1000/- is payable in advance.
The remaining amount is to be paid in two installments.

COURSES FOR DIPLOMA IN ELECTRICAL/ ELECTRONICS/MECHATRONICS ENGINEERING & IT'S EQUIVALENT

35 Jr. Embedded Developer

NSQF Level: 4.5

Objectives	After completion of course, the trainee will be able to develop programmes for Microcontrollers used in Industrial Applications, Work on Embedded Hardware & Software, Design Printed Circuit Board, Integrate Computer System to IOT Devices and Products.
Job Role	Developer
Duration	600 Hours/6 Months
Course Content	Embedded Program Development on different microcontroller, IoT application development on R-Pi and Node-MCU, Digital Logic design and Programming on FPGA and CPLD, Layout Design and Fabrication of PCB, Project, Employability Skills, On Job Training.



COURSES FOR DIPLOMA IN ELECTRICAL/ ELECTRONICS/MECHATRONICS ENGINEERING & IT'S EQUIVALENT

- Mode of Selection** → First come, First Serve Basis
- Course Fee** → Rs. 30,000/- (No Course fee for SC/ST Category Candidate)
- Course Starts on** → April, July, October & January

NOTE : Rs. 500/- extra for Assessment & Examination Fee.
A Registration Fee of Rs. 1000/- is payable in advance.
The remaining amount is to be paid in two installments.

COURSE FOR ITI IN MACHINIST/FITTER/TURNER

36 Certificate Course in Machining

- Objectives** → After completing the course, the trainee will be able to operate conventional machine tools, perform basic machining processes, select tools and parameters, interpret engineering drawings, ensure quality standards, and follow safety practices to become an effective entry-level machinist.
- Job Role** → Machine Operator
- Duration** → 600 Hours/6 Months
- Course Content** → Engineering Drawing Interpretation, Measurement Techniques, Operation of Conventional Machine Tools (Lathe, Milling, Drilling, Grinding), Cutting Tool Selection, Safe Machining Practices and Basic Quality Control.
- Mode of Selection** → First come, First Serve Basis
- Course Fee** → Rs. 24,000/- (No Course fee for SC/ST Category Candidate)
- Course Starts on** → April, July, October & January

NOTE : Rs. 500/- extra for Assessment & Examination Fee.
A Registration Fee of Rs. 1000/- is payable in advance.
The remaining amount is to be paid in two installments.



NSQF EXEMPTED TRAINING PROGRAMMES

COURSES FOR MECHANICAL/PRODUCTION/ AUTOMOBILE OR EQUIVALENT ENGINEERING

1. AutoCAD

- Creating Objects
- Blocks, Attributes & X-ref
- Editing Objects
- Layout, Plotting & Printing
- Layers, Color & Line type
- 3D Modeling
- Dimensioning & Tolerancing
- Drafting

Minimum Qualification: 10th Std. Pass or Above

Duration: 96 Hours (1 Month)

Course Fee: Rs. 4,100/-

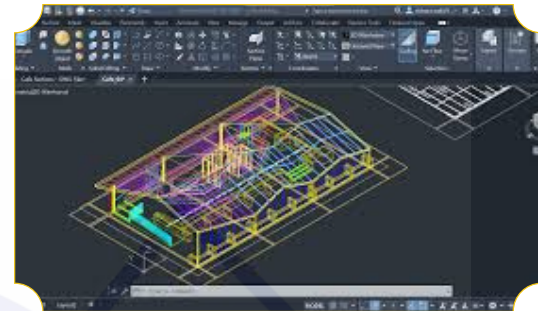

2. Creo Parametric

- Introduction to Creo
- Pro Surface
- Sketcher & Constraint
- Assembly Modelling
- Part Modelling
- Drafting & Detailing

Minimum Qualification: 10th Std. Pass or Above

Duration: 96 Hours (1 Month)

Course Fee: Rs. 5,100/-

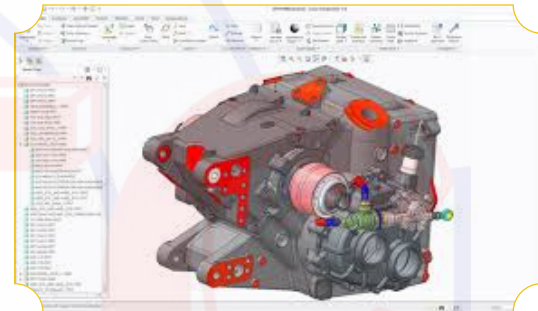

3. Delcam

- 2D Drafting
- Tool path Generation
- Wire Frame Modelling
- Post Processing & DNC
- Surface Modelling
- Solid Modelling

Minimum Qualification: 10th Std. Pass or Above

Duration: 96 Hours (1 Month)

Course Fee: Rs. 5,100/-



4. CATIA

- Sketcher & Constraint
- Part Design
- Assembly & Kinematics
- Drafting & Detailing
- Wireframe & Surface Design
- CATIA CAM

Minimum Qualification: 10th Std. Pass or Above

Duration: 96 Hours (1 Month)

Course Fee: Rs. 5,100/-

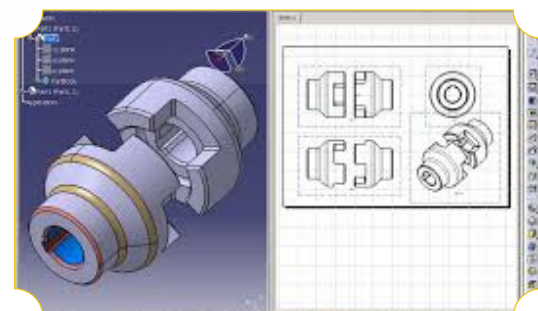

NSQF EXEMPTED TRAINING PROGRAMMES

COURSES FOR MECHANICAL/PRODUCTION/ AUTOMOBILE OR EQUIVALENT ENGINEERING

5. Solid Works

- Sketcher & Constraint
- Part Design
- Assembly & Kinematics
- Drafting & Detailing
- Wireframe & Surface Design
- Core & Cavity Extraction

Minimum Qualification: 10th Std. Pass or Above

Duration: 96 Hours (1 Month)

Course Fee: Rs. 5,100/-

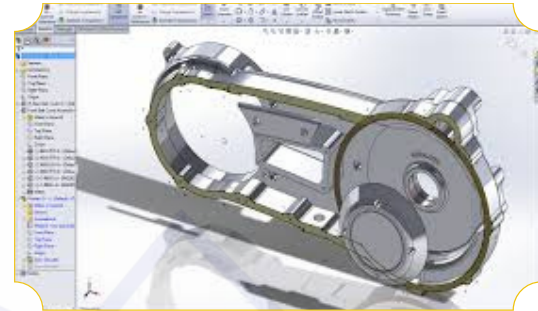

6. Ansys

- Introduction to FEA & ANSYS
- Structural Analysis (Linear, Non Linear, Dynamic)
- Thermal Analysis (Steady State & Transient)
- Couple Field Analysis

Minimum Qualification: 10th Std. Pass or Above

Duration: 96 Hours (1 Month)

Course Fee: Rs. 5,100/-

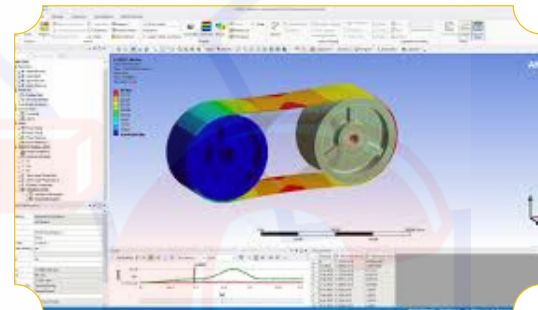

7. Mastercam

- 2D Drafting
- Tool path Generation
- Wire Frame Modelling
- Post Processing & DNC
- Surface Modelling

Minimum Qualification: 10th Std. Pass or Above

Duration: 96 Hours (1 Month)

Course Fee: Rs. 5,100/-

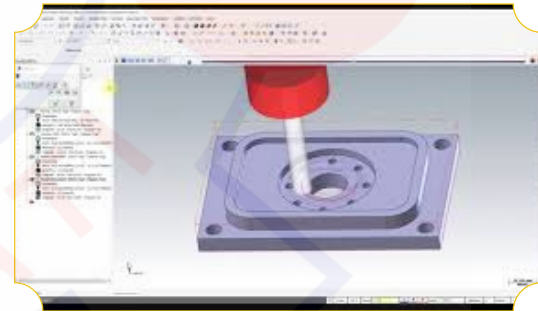

8. Unigraphics (NX)

- Introduction to Unigraphics
- Concept of Sketch & Constraints
- Part Modelling (Solid & Surface)
- Assembly
- Drafting & Detailing
- UG Manufacturing (Milling & Lathe)
- Post Processing & DNC

Minimum Qualification: 10th Std. Pass or Above

Duration: 96 Hours (1 Month)

Course Fee: Rs. 5,100/-

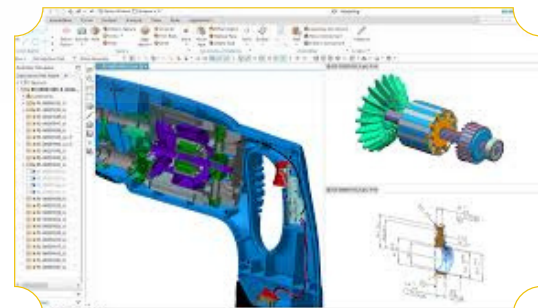

NSQF EXEMPTED TRAINING PROGRAMMES

COURSES FOR MECHANICAL/PRODUCTION/ AUTOMOBILE OR EQUIVALENT ENGINEERING

9. 3D Printing

- Introduction to Additive Manufacturing
- Classification of Additive Manufacturing
- Introduction to 3D Printing
- Demonstration of IdeaMaker
- Demonstration of 3D Printing Machine
- Post Processing Procedure

Minimum Qualification: 10th Std. Pass or Above

Duration: 96 Hours (1 Month)

Course Fee: Rs. 5,100/-



10. CNC Programming on Lathe

- Introduction to CNC Program
- CNC Programming Procedure
- Specification of CNC Turning
- Lathe operations CNC Cycles
- Facing, Roughing, Finishing etc.
- Selection of Cutting Tools

Minimum Qualification: 10th Std. Pass or Above

Duration: 96 Hours (1 Month)

Course Fee: Rs. 5,100/-



11. CNC Machining on Lathe

- Introduction of CNC lathe Machine
- Introduction G-Code M-Code for the Lathe programming.
- Fixture of lathe machine
- Lathe Machine programming
- Using of measuring instruments for Lathe Job Work

Minimum Qualification: 10th Std. Pass or Above

Duration: 96 Hours (1 Month)

Course Fee: Rs. 5,100/-



12. CNC Programming on Milling

- Introduction to CNC Program
- CNC Programming Procedure
- Specification of CNC Milling m/c
- Selection of Cutting tools
- Milling operations CNC Cycles
- Emco CNC Simulator

Minimum Qualification: 10th Std. Pass or Above

Duration: 96 Hours (1 Month)

Course Fee: Rs. 5,100/-



NSQF EXEMPTED TRAINING PROGRAMMES

COURSES FOR MECHANICAL/PRODUCTION/ AUTOMOBILE OR EQUIVALENT ENGINEERING

13. CNC Machining on Milling

- Introduction to CNC Milling Machine, Control Panel & Its Working
- Jig & Fixture use in Machine
- CNC Milling Programming Practice
- Use of Measuring Instruments for Any Job

Minimum Qualification: 10th Std. Pass or Above

Duration: 96 Hours (1 Month)

Course Fee: Rs. 5,100/-



COURSES FOR CIVIL ENGINEERING

14. STAAD Pro

- Basic Concepts of 2D & 3D in AutoCAD
- Creating Geometry using different methods in X,Y,Z co-ordinates
- Defining about Beams, Column & Plates
- Support & Properties System
- Different Steel & Load Systems
- Analysis with concrete & Steel

Minimum Qualification: 10th Std. Pass or Above

Duration: 96 Hours (1 Month)

Course Fee: Rs. 5,100/-

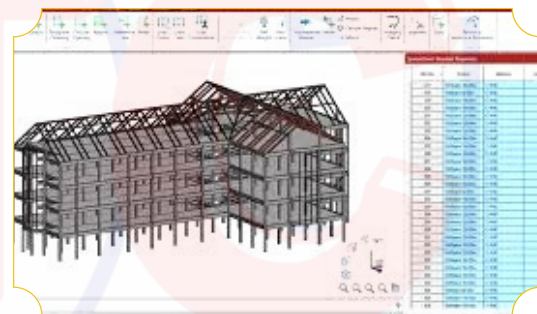

NSQF EXEMPTED TRAINING PROGRAMMES

COURSES FOR CIVIL ENGINEERING

15. 3Ds Max

- Introduction to 3Ds Max
- Plan conversion from AutoCAD
- Using of Standard Primitives, Compound Object, Shapes
- Copy, Move, Rotate & other Standard Modification Tools
- Creation of Door, Window, Stair, Railing, AEC Wall, Foilage
- Material Library
- Command Panel
- Interior Design Techniques
- Types of Camera & Light, Rendering & Exporting

Minimum Qualification: 10th Std. Pass or Above

Duration: 96 Hours (1 Month)

Course Fee: Rs. 5,100/-

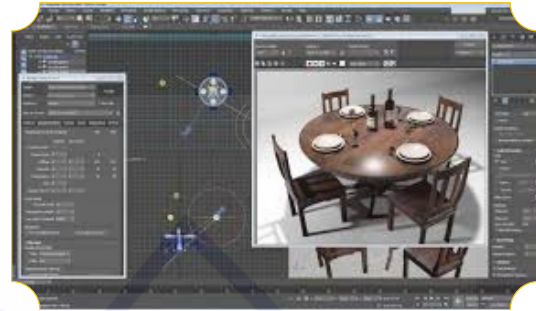

16. Revit Architecture

- Introduction to Revit
- Set up of Units & Element Properties
- Architectural Modelling
- Editing Tools & Managing Views
- Circulation Elements
- Annotating & Detailing
- Annotating Presentation Tools
- Rendering & Lighting

Minimum Qualification: 10th Std. Pass or Above

Duration: 96 Hours (1 Month)

Course Fee: Rs. 5,100/-

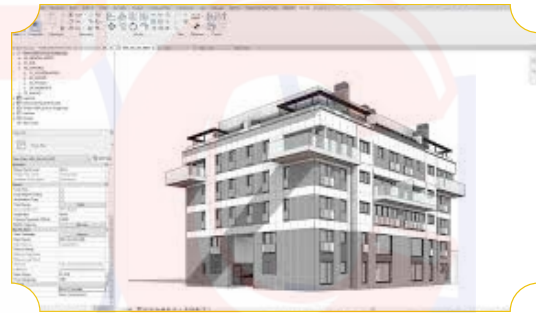

COURSES FOR ELECTRICAL/ELECTRONICS & EQUIVALENT ENGINEERING

17. PLC Programming

- Instrumentation in process industry
- Introduction of SCAD
- One line diagram & wiring guidelines
- PLC Hardware Components
- Power supply CPU
- I/O Communication
- Counter file handling
- SCADA Applications
- Application of Electrical Drivers
- PLC software timer

Minimum Qualification: 10th Std. Pass or Above

Duration: 96 Hours (1 Month)

Course Fee: Rs. 5,100/-

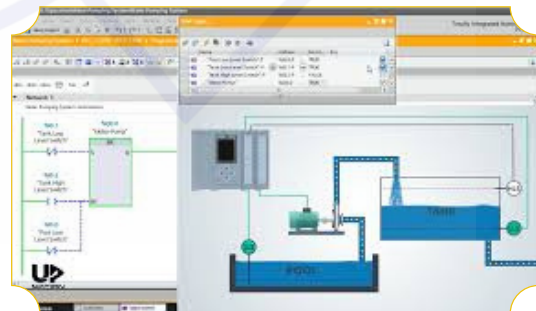

NSQF EXEMPTED TRAINING PROGRAMMES COURSES FOR ELECTRICAL/ELECTRONICS & EQUIVALENT ENGINEERING

18. VLSI

- Introduction of VLSI
- Semiconductor Physics
- Analog/ Digital Electronics, EDA Tools
- CMOS & layout design using MICROWIND
- VHDL & Verilog HDL programming & simulation using XILINX & ALTERA QUARTUS
- Interfacing of PLDs (SPARTAN, VIRETEX, CYCLONE)
- Analog circuit design and verification through FPAA using ANADIGM
- Basics of Microcontroller
- Project Work



Minimum Qualification: 10th Std. Pass or Above
Duration: 96 Hours (1 Month)
Course Fee: Rs. 5,100/-

19. Electrical CAD

- Electrical Controlling & Protection
- Device
- Brief on Auto CAD Commands
- Introduction to E-CAD
- Schematic Wiring
- Schematic Components
- Electric circuit and panel Design
- Lay out, Plotting and Printing

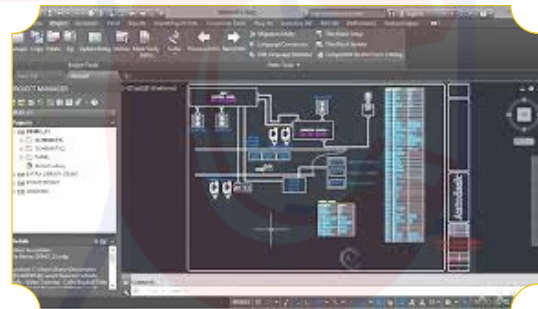

Minimum Qualification: 10th Std. Pass or Above
Duration: 96 Hours (1 Month)
Course Fee: Rs. 4,100/-

20. Embedded System

- Introduction, Components, Power
- Supply Circuit, MP&MCU
- Architectures, EDA Tools Working
- Embedded C & Assembly Language
- Timers, Counters, Interrupts, Serial
- Communication Protocols
- Interfacing Peripherals LED, Relay
- 7-Segment, LCD, Switch, Keypad
- DC motor, Stepper motor, RFID
- RTC, EEPROM etc.

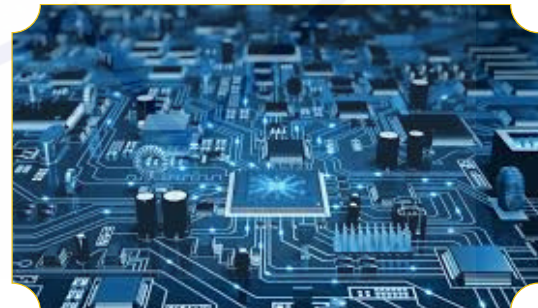

Minimum Qualification: 10th Std. Pass or Above
Duration: 96 Hours (1 Month)
Course Fee: Rs. 5,100/-

NSQF EXEMPTED TRAINING PROGRAMMES COURSES FOR ELECTRICAL/ELECTRONICS & EQUIVALENT ENGINEERING

21. SCADA

- Introduction to SCADA
- Role in Industrial Automation
- Remote Terminal Units (RTUs)
- Programmable Logic Controllers (PLCs)
- Input/Output (I/O) Modules
- SCADA Interface and Dashboard Design
- Tag Creation and Data Mapping
- Alarm Configuration and Event Logging
- Developing Control Logic and Process Automation

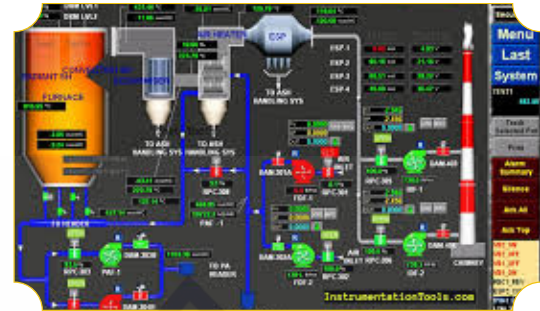

Minimum Qualification: 10th Std. Pass or Above

Duration: 96 Hours (1 Month)

Course Fee: Rs. 5,100/-

22. MATLAB

- Parallel Computing
- Math, Statics & Optimization
- Control System Design & Analysis
- Signal Processing & Communication
- Test & Measurement
- Code Generation & Verification
- Application Development
- Database Connectivity & Reporting

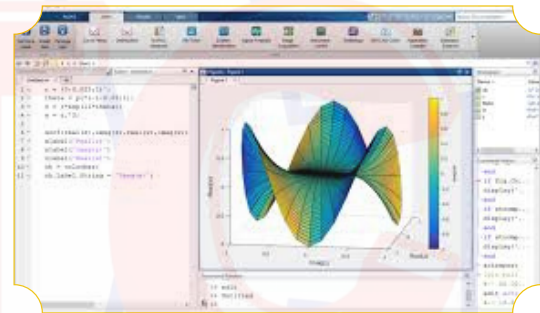

Minimum Qualification: 10th Std. Pass or Above

Duration: 96 Hours (1 Month)

Course Fee: Rs. 5,100/-

NSQF EXEMPTED TRAINING PROGRAMMES

COURSES FOR ANY ENGINEERING STUDENTS/GRADUATES

23. Computer Hardware & Networking

- Computer Fundamentals & MS DOS
- Computer Architecture
- Network Fundamentals
- System Management & Trouble Shooting

Minimum Qualification: 10th Std. Pass or Above

Duration: 96 Hours (1 Month)

Course Fee: Rs. 5,100/-



24. JAVA

- Object Oriented Programming Concepts
- Input & Output in JAVA
- Polymorphism
- Interface in JAVA
- Exception Handling
- SWING, Networking in JAVA
- JAVA Database Connectivity

Minimum Qualification: 10th Std. Pass or Above

Duration: 96 Hours (1 Month)

Course Fee: Rs. 4,100/-

```
import java.io.*;
import java.util.Date;

public class SaveDate {

    public static void main(String arg[]) throws Exception {
        FileOutputStream fos = new FileOutputStream("save.dat");
        ObjectOutputStream oos = new ObjectOutputStream(fos);
        Date date = new Date();
        oos.writeObject(date);
        oos.flush();
        oos.close();
        fos.close();
    }
}
```

NSQF NON-EXEMPTED TRAINING PROGRAMMES

COURSES FOR ANY ENGINEERING STUDENTS/GRADUATES

01. Suryamitra (Solar PV Installation)

- Introduction to Solar PV Installer
- Basics of Solar Energy & Electrical Concepts
- Solar PV System Fundamentals
- Tools & Equipment for Solar Installation
- Site Survey & Load Assessment
- Installation of Mounting Structure

Minimum Qualification: 10th Std. Pass or Above

Duration: 96 Hours (1 Month)

Course Fee: Rs. 4,100/-



02. Hydraulics & Pneumatics

- Hydraulic System Fundamentals
- Hydraulic Actuators
- Hydraulic Circuits & Troubleshooting
- Pneumatics Fundamentals
- Pneumatic Actuators
- Electro-Pneumatics & Electro-Hydraulics

Minimum Qualification: 10th Std. Pass or Above

Duration: 96 Hours (1 Month)

Course Fee: Rs. 4,100/-



03. LabVIEW

- Introduction to LabVIEW
- Programming Basics in LabVIEW
- Arrays, Clusters & Graphs
- Pneumatics Fundamentals
- Pneumatic Actuators
- Electro-Pneumatics & Electro-Hydraulics

Minimum Qualification: 10th Std. Pass or Above

Duration: 96 Hours (1 Month)

Course Fee: Rs. 5,100/-

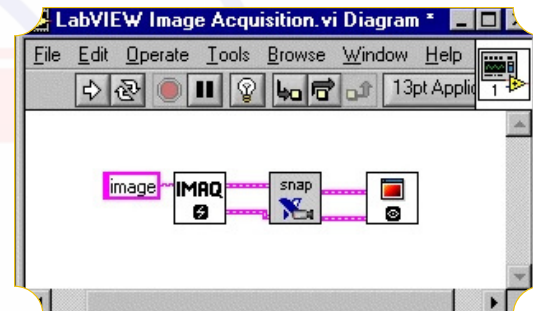

04. Survey & GIS

- Fundamentals of Surveying
- Chain & Compass Survey
- Levelling
- Introduction to GIS
- GIS Software Training
- Spatial Analysis & Mapping

Minimum Qualification: 10th Std. Pass or Above

Duration: 96 Hours (1 Month)

Course Fee: Rs. 5,100/-



NSQF NON-EXEMPTED TRAINING PROGRAMMES

COURSES FOR ANY ENGINEERING STUDENTS/GRADUATES

05. Electrical Machine Lab

- DC Machines
- Transformers
- AC Machines – Induction Motors
- AC Machines – Synchronous Machines
- Special Machines

Minimum Qualification: 10th Std. Pass or Above

Duration: 96 Hours (1 Month)

Course Fee: Rs. 4,100/-



06. Python Programming

- Introduction to Python
- Python Basics
- Control Statements
- Data Structures
- Functions and Modules
- File Handling

Minimum Qualification: 10th Std. Pass or Above

Duration: 96 Hours (1 Month)

Course Fee: Rs. 4,100/-



07. Artificial Intelligence & Machine Learning

- Introduction to Artificial Intelligence
- Programming for Machine Learning – Python
- Data Handling and Visualization
- Fundamentals of Machine Learning
- Supervised Learning Algorithms
- Introduction to Deep Learning

Minimum Qualification: 10th Std. Pass or Above

Duration: 96 Hours (1 Month)

Course Fee: Rs. 5,100/-



NSQF NON-EXEMPTED TRAINING PROGRAMMES

COURSES FOR ANY ENGINEERING STUDENTS/GRADUATES

08. Core JAVA

- Introduction to Java
- Java Basics
- Control Statements
- Object Oriented Programming
- Arrays and Strings
- Packages and Access Modifiers

Minimum Qualification: 10th Std. Pass or Above
 Duration: 96 Hours (1 Month)
 Course Fee: Rs. 5,100/-



09. SAP Business One

- Introduction to ERP & SAP Business One
- Master Data Management
- Financial Accounting
- Sales & Purchasing
- Inventory & Warehouse Management
- Production & MRP

Minimum Qualification: 10th Std. Pass or Above
 Duration: 96 Hours (1 Month)
 Course Fee: Rs. 5,100/-

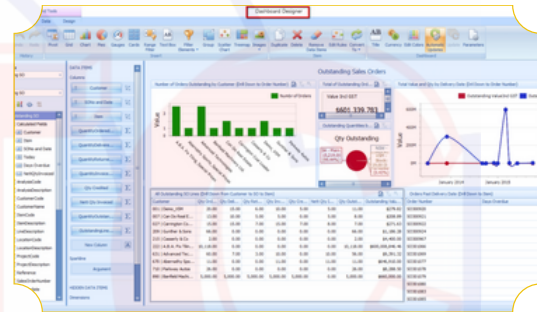

10. Programming in C/C++

- Introduction to Programming & C Language
- Operators and Expressions
- Control Statements
- Introduction to C++
- Data Types and Operators
- Control Statements

Minimum Qualification: 10th Std. Pass or Above
 Duration: 96 Hours (1 Month)
 Course Fee: Rs. 3,100/-

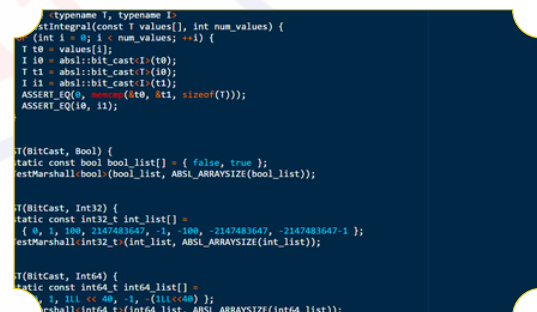

NSQF NON-EXEMPTED TRAINING PROGRAMMES

COURSES FOR ANY ENGINEERING STUDENTS/GRADUATES

11. Internet of Things (IoT)

- Introduction to IoT
- Basics of Electronics & Sensors
- Microcontrollers & Development Boards
- Programming for IoT
- Communication Protocols
- Cloud & IoT Platforms

Minimum Qualification: 10th Std. Pass or Above

Duration: 96 Hours (1 Month)

Course Fee: Rs. 4,100/-



12. Server Administration

- Introduction to Server & IT Infrastructure
- Computer Networking Fundamentals
- Windows Server Administration
- Linux Server Administration
- Web & Application Servers
- Server Security & Monitoring

Minimum Qualification: 10th Std. Pass or Above

Duration: 96 Hours (1 Month)

Course Fee: Rs. 4,100/-

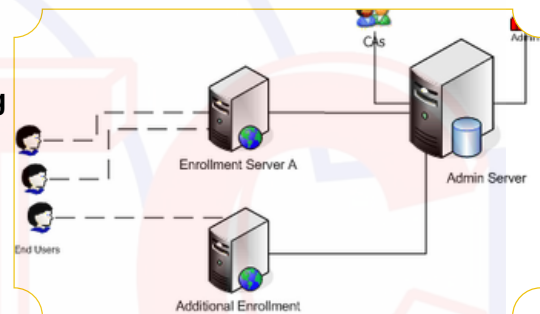

13. Graphic Designing

- Fundamentals of Graphic Design
- Adobe Photoshop
- Adobe Illustrator
- Adobe InDesign/CorelDRAW
- Digital & Social Media Design
- Portfolio Development & Freelancing

Minimum Qualification: 10th Std. Pass or Above

Duration: 96 Hours (1 Month)

Course Fee: Rs. 5,100/-



NSQF NON-EXEMPTED TRAINING PROGRAMMES

COURSES FOR ANY ENGINEERING STUDENTS/GRADUATES

14. Web Designing & Developing

- Introduction to Web Technologies
- HTML5 (Web Structure)
- CSS3 (Web Styling)
- JavaScript
- PHP/Python/Node.js
- MySQL

Minimum Qualification: 10th Std. Pass or Above

Duration: 96 Hours (1 Month)

Course Fee: Rs. 5,100/-



15. 3D Animator

- Introduction to Animation
- Drawing & Design Fundamentals
- Digital Illustration Tools
- Character Design
- Storyboarding & Layout
- 3D Animation Software

Minimum Qualification: 10th Std. Pass or Above

Duration: 96 Hours (1 Month)

Course Fee: Rs. 5,100/-

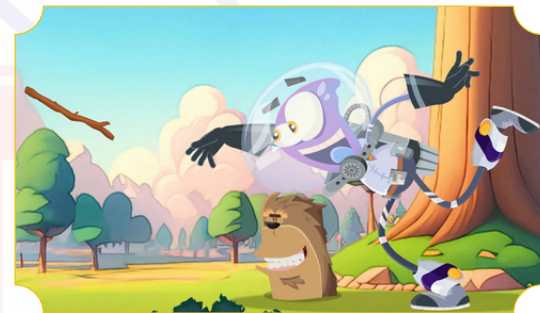

16. Soft Skills

- Introduction to Soft Skills
- Communication Skills
- Personality Development
- Teamwork & Interpersonal Skills
- Time Management & Work Ethics
- Problem Solving & Decision Making

Minimum Qualification: 10th Std. Pass or Above

Duration: 96 Hours (1 Month)

Course Fee: Rs. 3,100/-



NSQF NON-EXEMPTED TRAINING PROGRAMMES

COURSES FOR ANY ENGINEERING STUDENTS/GRADUATES

17. Entrepreneurship Skill Development Programme

- Introduction to Entrepreneurship
- Idea Generation & Opportunity Identification
- Business Planning
- Financial Management
- Marketing & Sales Management
- Operations & Human Resource Management

Minimum Qualification: 10th Std. Pass or Above

Duration: One Week

Course Fee: Rs. 2,100/-

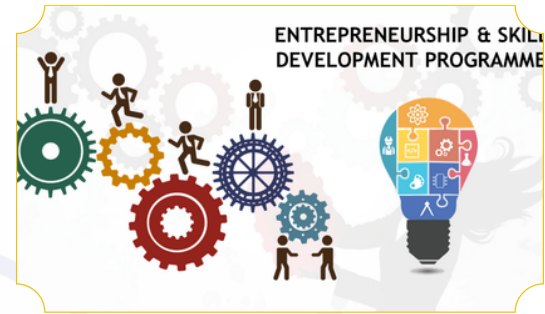

- We are conducting various Industry Need-Based Sponsored Training Programmes as per requirement.
- We are conducting Summer & Winter Vacation/Internship Training Programmes for engineering students of different branches.

OUR PLACEMENT PARTNER





GENERAL INFORMATION

ADMISSION CRITERIA:

Eligible candidates will be offered admission on first-cum-first-serve basis for selected courses on depositing Registration Fees (As per Course Details) by DD in favour of “**Tool Room & Training Centre, Guwahati, payable at Amingaon, Guwahati** along with filled up Admission Form. The Admission Form along with the prospectus can be obtained from our official website www.trtcguwahati.org or in person from **Tool Room & Training Centre, Guwahati** or on a request for Admission Form through E-Mail by giving full postal address. The Registration Fee of Rs. 1,000/- will be paid in advance, the same will be adjusted with the total Course Fee. Admission Process for Individual courses as indicated in Course Details. 22.5% seats are reserved for SC/ ST category (as per Government norms). Candidates belonging to reserved category should substantiate their claim by enclosing a Caste Certificate issued by Competent Authority.

HOSTEL ACCOMMODATION:

Separate Hostel Facilities may be provided for outstation boys & girls subject to availability of the accommodation at the discretion of the institute on extra cost as applicable.

RULES FOR AWARDING OF CERTIFICATE:

The evaluation system consists of continuous assessment of each module subject to assess the performance of the trainee. Trainee should have minimum 80% attendance.

GENERAL RULES & REGULATION FOR TRAINEE

1. Prescribed Application Form must be filled up, signed and submitted along with 4 copies of colour passport size photographs.
2. Course Fee once deposited will not be refunded.
3. Applicant should attend the training programme in the time fixed by Tool Room & Training Centre, Guwahati.
4. Applicant should maintain discipline during his/her undergoing training at Tool Room & Training Centre, Guwahati.
5. Holiday will be as per Tool Room & Training Centre, Guwahati holiday list and the specific holiday for the specific training programme.
6. Tool Room & Training Centre, Guwahati reserve the right to terminate any trainee during the training programme for any acts of the trainee, which may cause of damage Tool Room & Training Centre, Guwahati image.
7. Tool Room & Training Centre, Guwahati has the right to introduce new rules & regulation and modify/amend the existing rules at any time which have to follow the trainee.
8. Trainee must wear their uniform & shoes in all the training period.
9. Attendance of class should be maintained at least 80% in average.
10. Trainee who avail hostel facilities they should maintain general rules of hostel.
11. During training period, trainee are not allowed Pan, Pan Masala, Gutkha, Cigarette, Alcohol or any other types of unhygienic addiction etc. within the premises of Tool Room & Training Centre, Guwahati.
12. If any item/property of Tool Room & Training Centre, Guwahati will be damaged by the trainee, they have to replace the same within one week.
13. Trainee are not allowed to bring Laptop, Camera, CD, Pen Drive etc. to the campus.
14. Tool Room & Training Centre, Guwahati reserve the right to change the contents & schedule of the training programme without prior notice.
15. Commencement of the training programme is subject to registration status.
16. Reservation of seats as per the policy of Govt. of India.
17. Cash payment will not be acceptable.
18. All payment to be made by Credit Card/Debit Card/UPI/Demand Draft in favour of “Tool Room & Training Centre, Guwahati”.

HOW TO REACH TOOL ROOM & TRAINING CENTRE, GUWAHATI

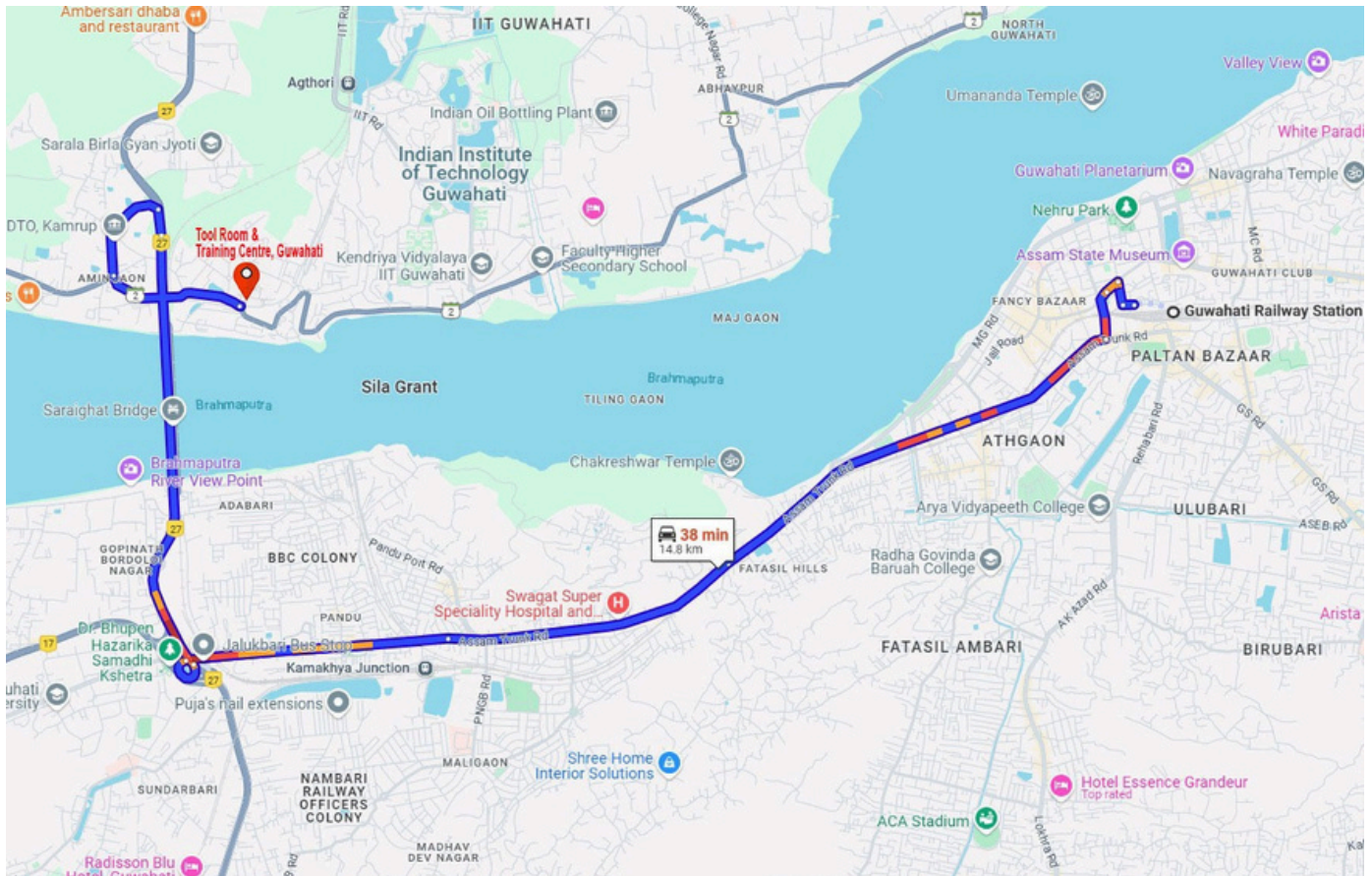

Guwahati Airport, officially known as Lokpriya Gopinath Bordoloi International Airport, is the primary airport serving Assam and the northeastern region of India. Located in Borjhar, about 25 km from the heart of Guwahati city, it connects the region to major cities across India and international destinations.

The Tool Room & Training Centre (TRTC), Guwahati, is situated approximately 17.6 KM from Guwahati Airport and is well-connected by road, ensuring convenient access for students and visitors.

Guwahati Railway Station is a major transportation hub in Northeast India, situated in the heart of Guwahati city, Assam. It plays a crucial role in connecting the northeastern region with the rest of the country.

Tool Room & Training Centre (TRTC), Guwahati, is located approximately 14.8 KM from Guwahati Railway Station and is easily accessible through a frequent network of local trains, ensuring convenient travel for students and visitors.

Tool Room & Training Centre (TRTC), Guwahati, is located approximately 1.4 KM from NH 31 and is easily accessible from the Adabari and Jalukbari Bus Stands, where local buses and tempos operate frequently, ensuring convenient transportation for students and visitors.

Guwahati, the largest city in Assam and the entire Northeastern Region of India, is often called the "Gateway to Northeast India." As a major Commercial, Educational, and Cultural Hub, it thrives on the banks of the Brahmaputra River, surrounded by scenic hills. With landmarks like the Kamakhya Temple and its rich historical ties to the ancient Kamarupa Kingdom, Guwahati beautifully blends tradition with modern development.





Conducted Skill Development Certificate Course in Basic Computer under Operation Sadbhavana for the General Public, Students & Govt. Employees of Mechukha, Dist. Shi Yomi, Arunachal Pradesh in coordination with Indian Army (1821 Med. Regt.).



Internship Programmes under NEP in Assam.



Summer Internship Skill-Based Hands-on Training for Engineering Students from different Colleges of Assam.



FOR MORE INFORMATION, PLEASE CONTACT

9707604732/9864820996/9864121545

9957345395/6026750618



TOOL ROOM & TRAINING CENTRE, GUWAHATI

Ministry of Micro, Small & Medium Enterprises, Govt. of India

Amingaon Industrial Area, North Guwahati Road, Amingaon, Guwahati - 31

Website: www.trtcguwahati.org

Email: trtcghy@hotmail.com/trtcplacement@hotmail.com